



Neutron Series Outdoor Access Points

Neutron Series Outdoor Managed Access Points

Optimal Performance in Harsh Environments

EnGenius' Neutron Series line of Managed Outdoor Access Points provides wireless connectivity that's flexible, scalable and reliable for outdoor applications.

Whether you are looking to provide ultra-fast Wi-Fi access to a resort pool, campus quad, or other outdoor property, Neutron EWS Access Points meet the high-bandwidth requirements of today's mobile users.

No matter what size network you need to support, Neutron EWS Access Points are flexible enough to meet your needs. Start small and grow or go big. Deploy and manage a few or 1,000+ APs on an unlimited number of networks distributed across various locations—regardless of their size and infrastructures. Neutron Series easily scales with your networking needs.

Features & Benefits

- High-Capacity 11ac Wave 2 Speeds to 2.5 Gbps
- Industrial-Grade IP68/IP67 & Ruggedized IP55-Rated Housing Withstands Harsh Environments
- Dual-Radio MU-MIMO Improves Performance, Expands Capacities
- Beamforming Technology Optimizes Signal, Reception & Reliability
- Versatile 4x4, 3x3 & 2x2 11ac Models with Internal & Detachable Antennas
- Operate as a Stand-Alone AP or Centrally Manage
- Remotely Manage 1-1,000+ APs via ezMaster™
- No Access Point Licensing or Subscription Fees
- GigE PoE-Compliant Ports for Placement in Unwired Areas
- Secondary GigE Port Connects & Powers IP Cameras or APs (select models)
- High-Transmit Power Ensures Greater Coverage Ranges

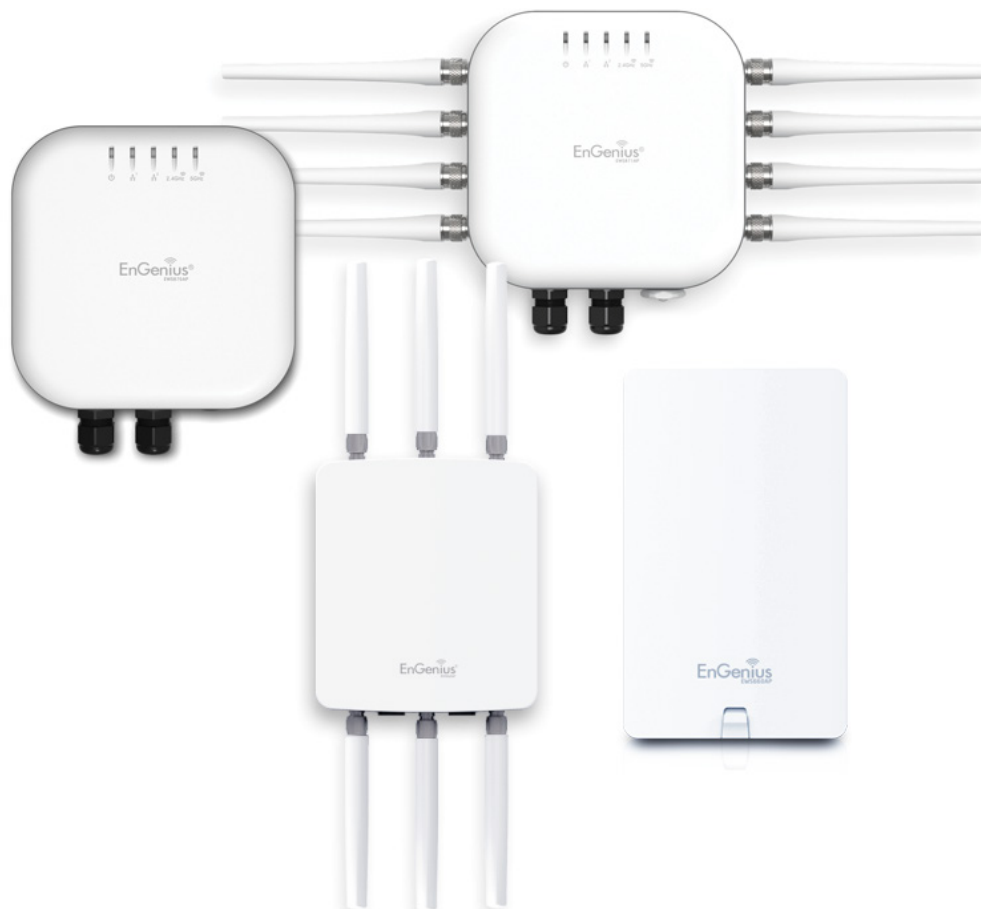

Ultra-Fast Wave 2 11ac Speeds

EnGenius' 11ac Wave 2 Access Points deliver the highest available speeds for Wi-Fi devices reaching 2.5 Gbps. Beamforming technology focuses signals directly to client devices, providing optimal, reliable reception even in densely crowded outdoor environments. Four spatial streams and dual-concurrent MU-MIMO radio operation sends beams to multiple users simultaneously, creating increased network capacity and performance.

Peak Performance in Harsh Environments

Designed to perform in harsh conditions, Neutron EWS Outdoor Access Points feature industrial-grade IP68 to IP55-rated enclosures, ensuring the APs can withstand extreme outdoor climates and indoor industrial environments where the temperature is a factor. This includes prolonged outdoor exposure to sunlight, extreme cold, frost, snow, rain, hail, heat and humidity.



Optimized Connectivity

Neutron EWS Outdoor APs feature dual-band concurrent wireless coverage, high speeds and high-device capacities. Band Steering optimizes network traffic flow by automatically directing dual-band clients to the less congested 5 GHz band. Fast Roaming capability ensures seamless, reliable connectivity for mobile users as they move between outdoor APs.

Maximized Wi-Fi Coverage

EWS Outdoor APs are designed for peak performance in a variety of outdoor environments providing high-performance reception and long-range connections. High-transmit power reaches to 29dBm, ensuring reliable, long-range device coverage.

Protected by Advanced Encryption

With Neutron EWS APs, your network is protected from attacks at multiple levels through advanced wireless encryption standards such as Wi-Fi Protected Access Encryption and authentication. Network threats are quickly detected and avoided through rogue AP detection, email alerts and real-time wireless invasion monitoring, allowing for immediate action to divert network hacks and other security threats.

Secure Guest Networks

Organizations that offer Internet access to patrons or visitors— notably hotels, retail shops and restaurants—will appreciate Neutron's guest network capabilities. Establish a secure guest network that blocks access to main corporate computers. Create separate Virtual LANs for increased security, network reliability and bandwidth conservation.

Flexible Power-over-Ethernet Power Options

All Neutron EWS Outdoor Access Points feature at least one Gigabit PoE port, enabling placement in locations where power outlets are scarce or unavailable such as on poles or rooftop eaves. Power the APs through a connected Ethernet cable directly to a Neutron Managed Controller PoE+ Switch or with a PoE adapter up to 328 feet from the power source.

Simplified Deployment & Provisioning

In combination with Neutron Switches and ezMaster Network Management Software, Neutron EWS Outdoor APs are automatically discovered and provisioned. One-click individual or bulk configurations and upgrades save time. In addition, these access points are quickly and easily deployed and operated by users with limited networking experience.

Manage Up to 50 APs with Neutron Switches

Any Neutron Managed Switch can act as a wireless controller capable of managing up to 50 Neutron EWS Access Points. IT administrators have access to all connected Neutron devices and a full array of Layer 2 management tools. Choose between PoE+ and non-PoE switch models with flexible deployment and management options.

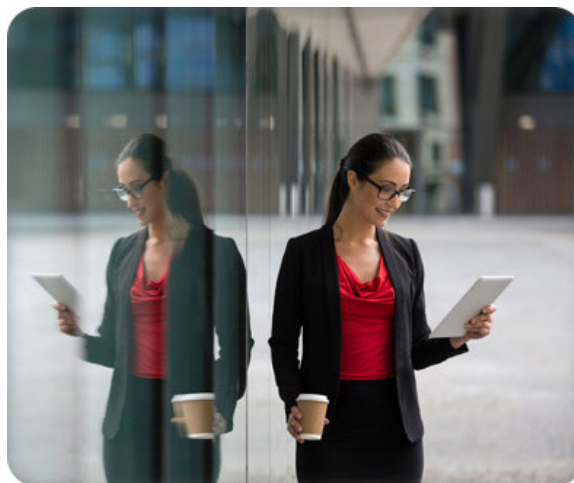

Flexible Distributed Network Management

EzMaster Network Management Software expands the flexibility and scalability of Neutron Series EWS Managed Access Points and Switches.

EzMaster allows organizations, such as branch offices and managed service providers, to easily and affordably deploy, monitor and manage a large number of Neutron APs, Controller Switches and Managed Smart Switches across geographically diverse properties. Centrally manage an unlimited number of independent distributed networks in the same subnet or cross-subnet from a single, at-a-glance network dashboard, no matter where they're located.

Deploy ezMaster locally, remotely or via a Cloud-based service with or without an onsite controller.

Powerful, Scalable Options

EzMaster scales with your growing business needs. Manage 1,000+ Neutron EWS Access Points and Switches and 10,000+ concurrent users. Together, Neutron APs, Switches and ezMaster provide a flexible, fully integrated solution with redundancy support and future expandability for broader device connectivity.

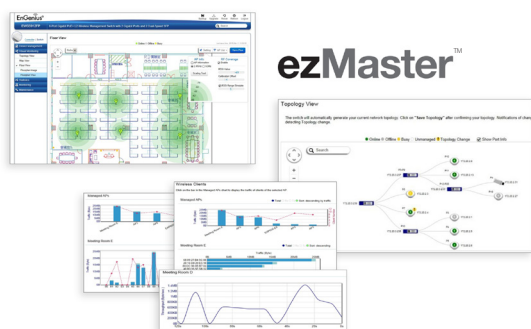

System Requirements

Recommended environment for managing up to 500 APs

CPU: Intel® Core™ i3 3.6 GHz dual-core or above
 RAM: 4 GB minimum
 HDD: 500 GB (actual requirement dependent on log size)
 OS: Microsoft® Windows® 7 or later + VMware® Player 7.0 or compatible virtualization software

Recommended environment for managing up to 1,000+ APs

CPU: Intel® Core™ i5 3.2 GHz quad-core or above
 RAM: 4 GB minimum
 HDD: 500 GB (actual requirement dependent on log size)
 OS: Microsoft® Windows® 7 or later + VMware® Player 7.0 or compatible virtualization software

Browser Requirements

Internet Explorer 10 or better
 Firefox 34.0 or better
 Chrome 31.0 or better
 Safari 8.0 or better

Network Topology Requirements

At sites where APs are deployed: A DHCP-enabled network for APs to obtain an IP address

Simplified Device Management

EzMaster Network Management Software makes centralized device management easy. How? Through centralized bulk configuration, provisioning and monitoring, a comprehensive at-a-glance network dashboard, rich analytics and reporting, and much more.

ezMaster Software Features

- **Centralized Management**
 - Configure, Managed & Monitor 1,000+ Neutron Devices
 - Cross-Network AP Management
 - AP Group Configuration
- **Access Point Configuration & Management**
 - Auto Channel Selection
 - Auto Tx Power
 - Background Scanning
 - Band Steering (Auto Band Steering & Band Balancing)
 - Client Isolation
 - Client Limiting
 - Fast Roaming
 - L2 Isolation
 - LED On/Off Control
 - Multiple SSID
 - RSSI Threshold
 - Secure Guest Network
 - Traffic Shaping
 - VLAN Isolation
 - VLAN Tag
- **Comprehensive Monitoring**
 - Device Status Monitoring
 - Floor Plan View
 - Map View
 - Rogue AP Detection
 - System Status Monitoring
 - Visual Topology View
 - Wireless Client Monitoring
 - Wireless Coverage View
 - Wireless Traffic & Usage Statistics
- **Management & Maintenance**
 - Bulk Firmware Upgrade
 - Captive Portal
 - Email Alert
 - ezRedundancy (Available 2016)
 - Kick/Ban Clients
 - One-Click Update
 - Remote Logging
 - Seamless Migration
 - SmartSync Redundancy (Available 2016)
 - Syslog

EnGenius Neutron Series Outdoor Managed Access Points

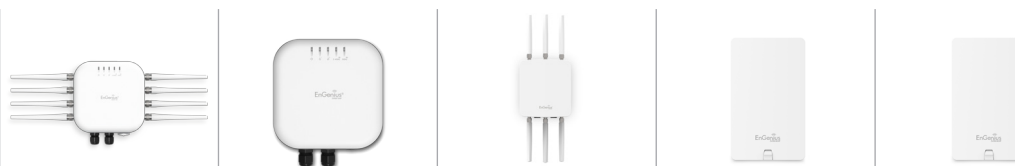

Models	EWS871AP	EWS870AP	EWS860AP	EWS660AP	EWS650AP
Standards	802.11b/g/n/ac	802.11b/g/n/ac	802.11a/b/g/n/ac	802.11a/b/g/n/ac	802.11b/g/n/ac
Frequency	2.4 & 5 GHz	2.4 & 5 GHz	2.4 & 5 GHz	2.4 & 5 GHz	2.4 & 5 GHz
2.4 GHz Max. Data Rate	800 Mbps	800 Mbps	450 Mbps	450 Mbps	300 Mbps
5 GHz Max. Data Rate	1,733 Mbps	1,733 Mbps	1,300 Mbps	1,300 Mbps	867 Mbps
Radio Chains/Streams	4 x 4:4	4 x 4:4	3 x 3:3	3 x 3:3	2 x 2:2
RF Output Power	27 dBm	27 dBm	29 dBm	29 dBm	27 dBm
Ingress Protection Rating	67	67	68	55	55
Primary Ethernet Port	1 x Gig Port	1 x Gig Port	1 x Gig Port	1 x Gig Port	1 x Gig Port
Secondary Ethernet Port	1 x Gig Port (PoE Output)	1 x Gig Port (PoE Output)	1 x Gig Port (PoE Output)	1 x Gig Port	1 x Gig Port
Console Interface	1 x RJ45	1 x RJ45	N/A	N/A	N/A
PoE Compliant	802.3at (PoE+)	802.3at (PoE+)	802.3at (PoE+)	802.3at (PoE+)	802.3at (PoE+)
Power Consumption (Peak)	21W (w/o PSE) 36W (w/PSE over LAN2)	21W (w/o PSE) 36W (w/PSE over LAN2)	32W	20W	20W
Integrated Antennas	-	4 x 3 dBi (2.4 GHz) 4 x 3 dBi (5 GHz)	N/A	6 x 5 dBi	2 x 5 dBi
External Antenna (N-Type)	4 x 5 dBi (2.4 GHz) 4 x 7 dBi (5 GHz)	N/A	2.4 GHz: 3 x 5 dBi 5 GHz: 3 x 7 dBi	N/A	N/A

Technical Specifications

Frequency

RF: 2.4 and 5 GHz Frequency Bands

Standards

IEEE 802.11a/b/g/n/ac

Radio I

11b/g/n: 2.412~2.484 GHz

Radio II

11a/n/ac: 5.18-5.24 and 5.26-5.32 and 5.5-5.7 and 5.745-5.825 GHz

Data Rates

EWS650AP

Up to 300 Mbps on 2.4 GHz; up to 867 Mbps on 5 GHz

EWS660AP / EWS860AP

Up to 450 Mbps on 2.4 GHz; up to 1300 Mbps on 5 GHz

EWS870AP / EWS871AP

Up to 2.5 GHz; Up to 800 Mbps on 2.4 GHz; up to 1733 Mbps on 5 GHz

Memory

256MB

Flash Memory

16MB

Power Consumption

EWS650AP Up to 23W

EWS660AP Up to 23W

EWS860AP Up to 34W

EWS870AP / EWS871AP Up to 21W (without PSE);
Up to 36W (with PSE over LAN 2)

EWS871AP Up to 21W (without PSE)

Antennas

EWS650AP / EWS660AP

Internal High Gain Antennas 5 dBi support both 2.4 GHz and 5 GHz (2) EWS350AP (6) EWS660AP

EWS860AP

External High Gain Antennas 3 x 5 dBi for 2.4 GHz

External High Gain Antennas 3 x 7 dBi for 5 GHz

Antennas continued

EWS870AP

Internal High Gain Antennas 3 dBi support both 2.4 GHz and 5 GHz (4/Band)

EWS871AP

External High Gain N-Type Antennas 4 x 5 dBi for 2.4 GHz

External High Gain N-Type Antennas 4 x 7 dBi for 5 GHz

Physical Interface

2 x RJ45 10/100/1000 Gigabit Ethernet Ports - PoE Capable 802.3at

1 x Reset Button

1 x Power Connector

EWS870AP / EWS871AP

2 x RJ45 10/100/1000 Gigabit Ethernet Ports (Link Aggregation achieves 2Gbps Throughput)

- LAN1: Supports 802.3at PoE Input

- LAN2: Data & 802.3af PoE Pass-Through

1 x Console Ethernet Port

1 x Reset Button

1 x Power Connector

Technical Specifications continued

LED Indicators
1 x Power
1 x 2.4 GHz
1 x 5 GHz
1 x WLAN (Wireless Connection)
1 x LAN
EWS870AP / EWS871AP
1 x Power
2 x WLAN (Wireless Connection)
2 x LAN (2.4GHz & 5GHz)
Power Requirements
Power Supply: 100 to 240V DC +/-10% 50/60 Hz
Active Ethernet (Power-over-Ethernet IEEE 802.3at)
PoE Injector DC IN, 48V/0.8A
EWS870AP / EWS871AP
DC IN, 48 V/1.25A
802.3at/48V-54V Input Compliant Source
Active Ethernet (PoE)
PSE Output
EWS870AP / EWS871AP
LAN2 802.3af power source w/ included power adapter
Surge Protection
EWS870AP / EWS871AP
4KV
ESD Protection
EWS870AP / EWS871AP
Contact: 6KV
Air: 8 KV
Modulations
OFDM: BPSK, QPSK, 16-QAM, 26-QAM, 64-QAM, 256-QAM, DBPSK, DQPSK, CCK
Radio Technologies
802.11b: Direct-Sequence Spread Spectrum (DSSS)
802.11a/g/n/ac: Orthogonal Frequency Division Multiplexing (OFDM)
Operating Channels
2.4 GHz US/Canada 1-11
5 GHz Country dependent for the following ranges: 36, 40, 44, 48, 52, 56, 60, 64, 100, 104, 108, 112, 116, 120, 124, 128, 132, 136, 140, 149, 153, 157, 161, 165
Operation Modes
Access Point
Multiple BSSID
Supports Up to 8 SSIDs Per Radio

SSID-to-VLAN Tagging
Supports 802.1q SSID-to-VLAN Tagging
Spanning Tree
Supports 802.1d Spanning Tree Protocol
Wireless
Wireless Mode: 11a/11b/11g/11n/11ac
Channel Selection (settings vary by country)
Channel Bandwidth (Auto, 20 MHz, 40 MHz, 80 MHz)
Transmission Rate
2.4 GHz 11n only, 11b/b/n mix, 11b only, 11b/g, 11g only
5 GHz 11ac only, 11n only, 11a/n mix, 11a only
EWS870AP / EWS871AP
Tx Beamforming (Tx BF)
EWS870AP / EWS871AP
SU-MIMO
(4) Spatial Streams to 1733 Mbps to Single Client
EWS870AP / EWS871AP
MU-MIMO
(3) Spatial Streams to 1300 Mbps to (3) MU-MIMO-Capable Devices Simultaneously
Wireless Management Features (with ezMaster & Neutron Switch)
Access Point Auto Discovery and Provisioning
Access Point Auto IP Assignment
Access Point Group Management
Remote Access Point Rebooting
Access Point Device Name Editing
Access Point Radio Settings
Band Steering
Traffic Shaping
Fast Roaming (802.11k & 802.11r)
Pre-Authentication (802.11i & 802.11x)
PMK Caching (802.11i)
RSSI Threshold
Access Point Client Limiting
Client Fingerprinting
Wireless Security (WEP, WPA/WPA2 Enterprise, WPA/WPA2 PSK)
AP VLAN Management
VLANs for Access Point- Multiple SSIDs
Secured Guest Network
Captive Portal
Access Point Status Monitoring
Rogue AP Detection
Wireless Client Monitoring
Background Scanning

Key Features

- 11ac Wave 2 4x4 Models
- Beamforming Technology
- Tough IP68- and IP55-Rated Housing
- Sectorized 3D Antennas
- Dynamic Channel Optimization
- Dual-Band (selected models)
- Band Steering (Dual-Band models)
- Fast Roaming
- Supports Connectivity of 100+ Users
- 16 SSIDs (8 SSIDs per frequency band)
- Wireless Traffic Shaping
- QoS
- SSID-to-VLAN Mapping
- Email Alert
- Wi-Fi Scheduler
- Auto-Reboot
- AP Detection

Wireless Management Features (with ezMaster & Neutron Switch) continued

Email Alert
Wireless Traffic & Usage Statistics
Real-Time Throughput Monitoring
SmartSync Redundancy
Visual Topology View
Floor Plan View
Map View
Wireless Coverage Display
Secure Control Messaging (SSL Certificate)
Local MAC Address Database
Remote MAC Address Database (RADIUS)
Unified Configuration Import / Export
Bulk Firmware Upgrade Capability
One-Click Update
Intelligent Diagnostics
Kick/Ban Clients
Wi-Fi Scheduler

Tx Power Control

Adjust Transmit Power by dBm

Configuration

Web-Based Configuration (http)

Firmware Upgrade

Via Web Browser

Administrator Settings

Administrator Username and Password Change

Technical Specifications continued

MIB

MIB I, MIB II (RFC1213) and private MIB

System Monitoring

Status Statistic and Event Log

SNMP

V1 / V2c / V3

Traffic Shaping

Incoming and Outgoing Wireless Traffic Shaping

Reset Settings

Reboot (press & hold for 2 seconds).
Reset to Factory Default (press & hold for 10 seconds)

Auto-Channel Selection

Automatically Selecting Least Congested Channel

Bandwidth Measurement

IP Range and Bandwidth Management

Schedule Reboot

Reboot Access Point by Minute, Hour, Day, or Week

Backup and Restore

Save and Restore Settings via Web Interface

CLI

Supports Command Line Interface

Diagnosis

IP Pinging Statistics

Log

SysLog and Local Log Support

LED Control

On/Off

AP Detection

Scanning for Available EnGenius APs

Wireless Security

WPA/WPA2 Personal (WPA-PSK using TKIP or AES)

WPA/WPA2 Enterprise (WPA-EAP using TKIP)

802.1X RADIUS Authenticator: MD5/TLS/TTLS, PEAP

SSID Broadcast Enable/Disable

MAC Address Filtering, Up to 50 Entries

L2 Isolation

EWS870AP / EWS871AP

WEP Encryption 64/128/152 bit

QoS (Quality of Service)

IEEE 802.11e

WMM (Wireless Multimedia)

Temperature Range

EWS650AP / EWS660AP

Operating: -4°F to 140°F (-20°C to 60°C)

Storage: -22°F to 176°F (-30°C to 80°C)

EWS860AP / EWS870AP / EWS871AP

Operating: -4°F to 158°F (-20°C to 70°C)

Humidity (non-condensing)

Operating: 90% or less

Storage: 90% or less

Weatherproof

EWS650AP IP55-Rated Enclosure

EWS660AP IP55-Rated Enclosure

EWS860AP IP68-Rated Enclosure

EWS870AP / EWS871AP IP67-Rated Enclosure

Device Dimensions and Weights

EWS650AP / EWS660AP

Weight: 1.89 lbs. (857.2 g)

Length: 11.97" (304 mm)

Width: 7.13" (181.1 mm)

Height: 1.81" (45.9 mm)

EWS860AP

Weight: 4.17 lbs. (1.8 kg)

Length: 11.22" (284.9 mm)

Width: 8.58" (217.9 mm)

Height: 2.10" (53.3 mm)

EWS870AP / EWS871AP

Weight: 6.61 lbs. (2.99 kg)

Length: 9.5" (241.2 mm)

Width: 8.23" (209 mm)

Height: 2.36" (59.9 mm)

Package Contents

Pole Mounting Bracket

Mounting Screw Set

Quick Installation Guide

EWS650AP

Power Adapter (48V/0.8A)

PoE Injector

EWS660AP

Power Adapter (12V/2A)

RJ45 Ethernet Cable

EWS860AP

Power Adapter (12V/2A)

3 x 5dBi Antennas (2.4 GHz)

3 x 7dBi Antennas (5 GHz)

RJ45 Ethernet Cable

EWS870AP / EWS871AP

Power Adapter (48V/1.25A)

PoE Injector (EPE-4818G)

EWS871AP

8 x Detachable N-Type Antennas

Certifications

FCC, IC, CE

Warranty

1-Year Standard

EWS650AP / EWS660AP Outdoor Access Points



- LED Indicators
- Power
 - WLAN (2.4 GHz)
 - WLAN (5 GHz)
 - LAN 1
 - LAN 2

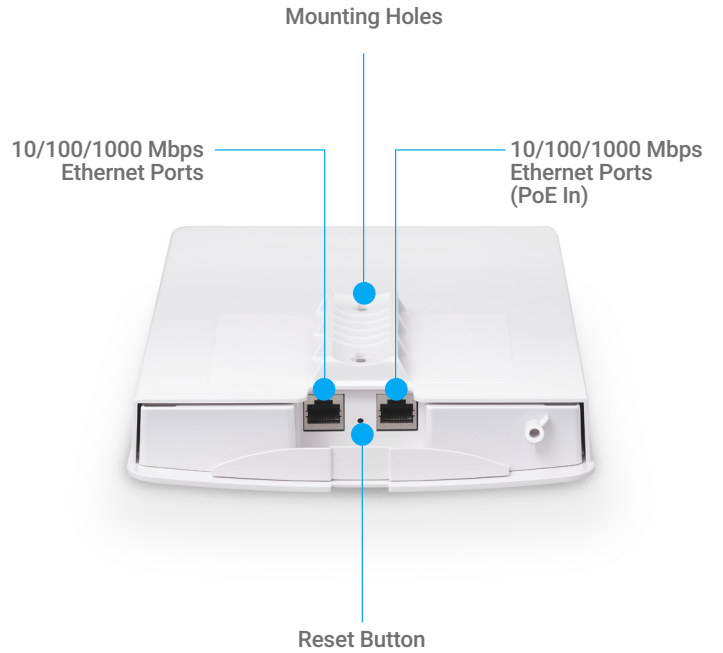

EWS860AP Outdoor Access Point

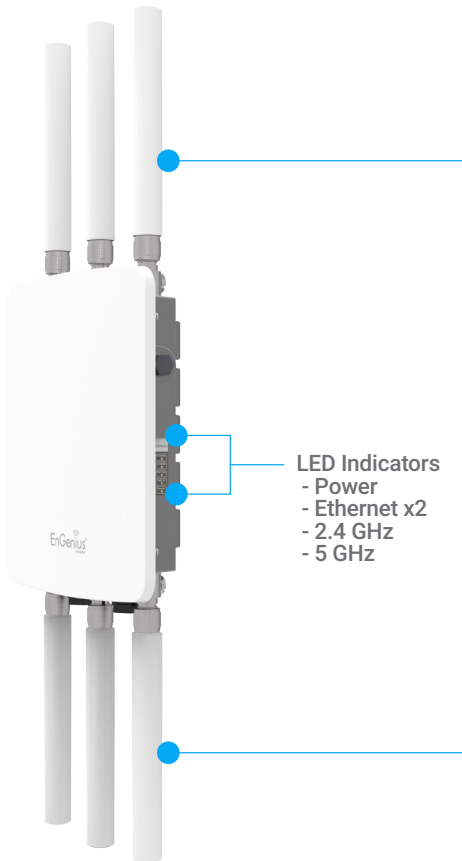

- LED Indicators
- Power
 - Ethernet x2
 - 2.4 GHz
 - 5 GHz

Detachable Antenna

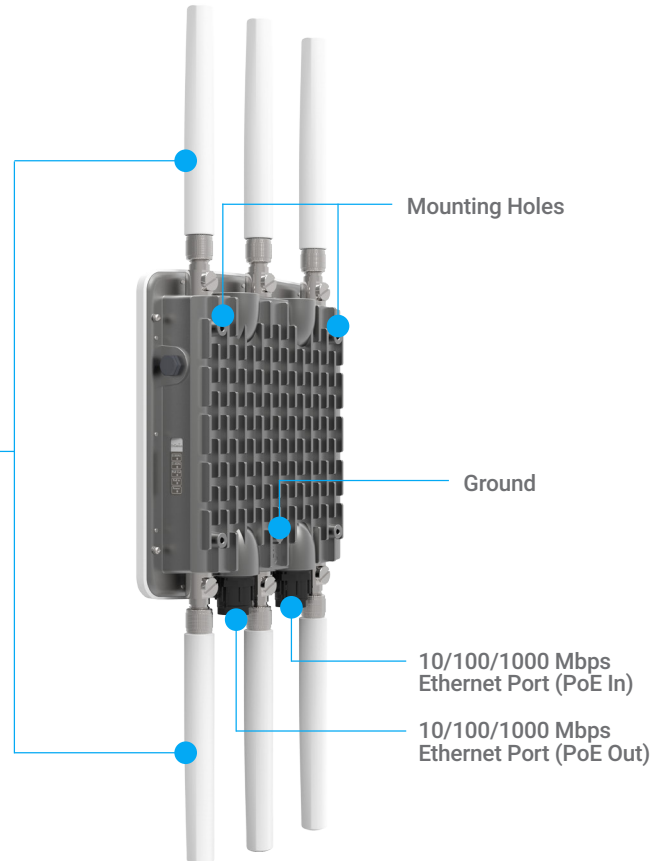

EWS870AP Outdoor Access Point

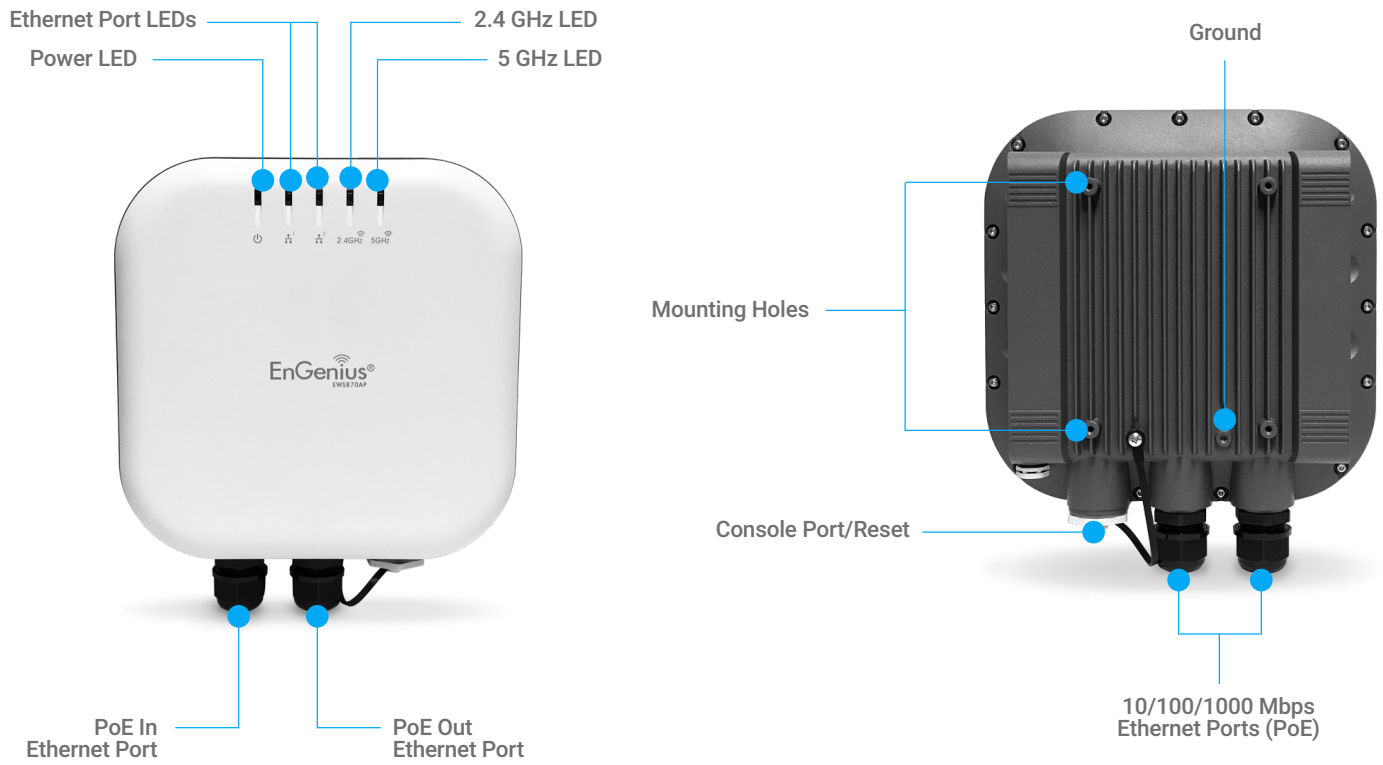

EWS871AP Outdoor Access Point

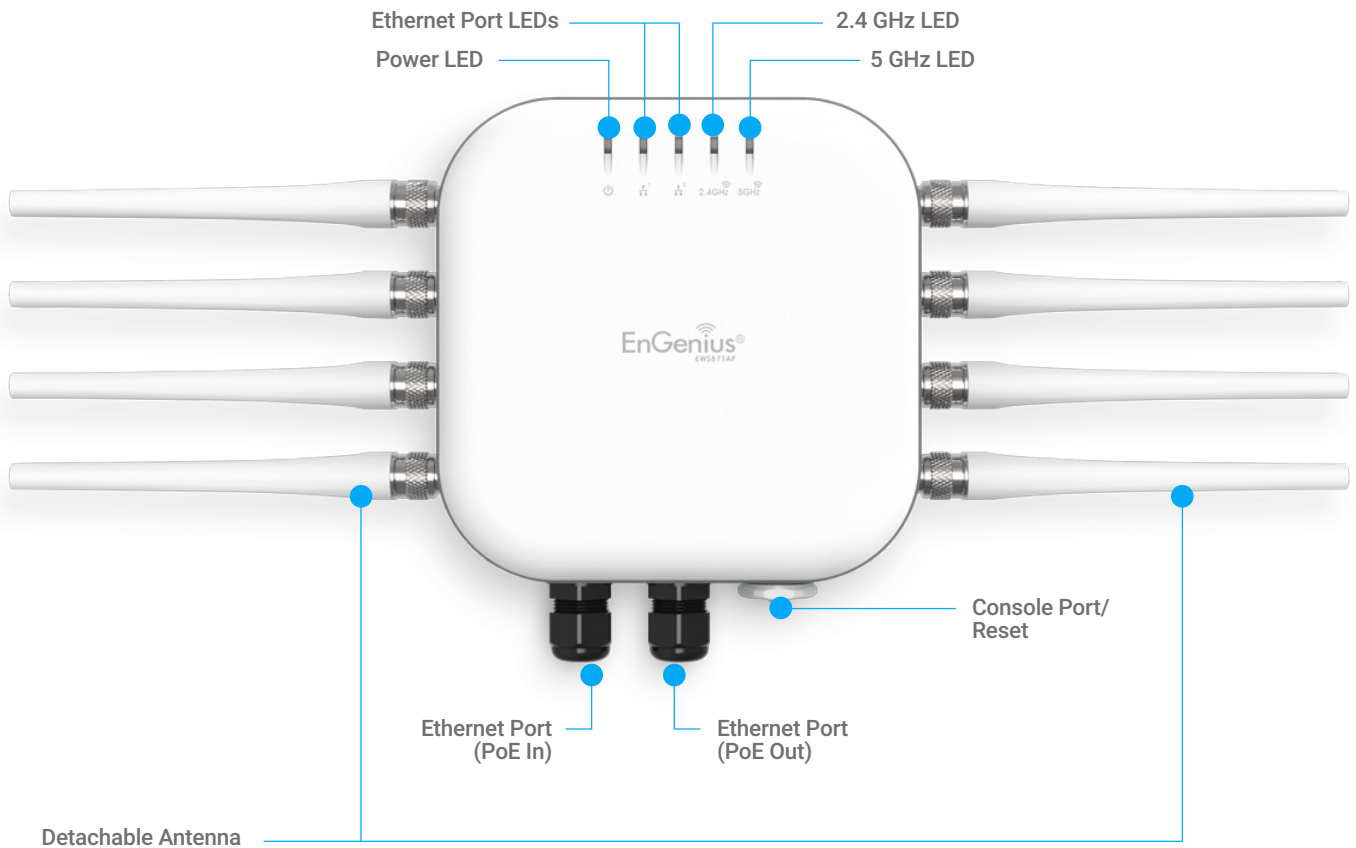

EWS871AP Outdoor Access Point continued

Mounting Holes

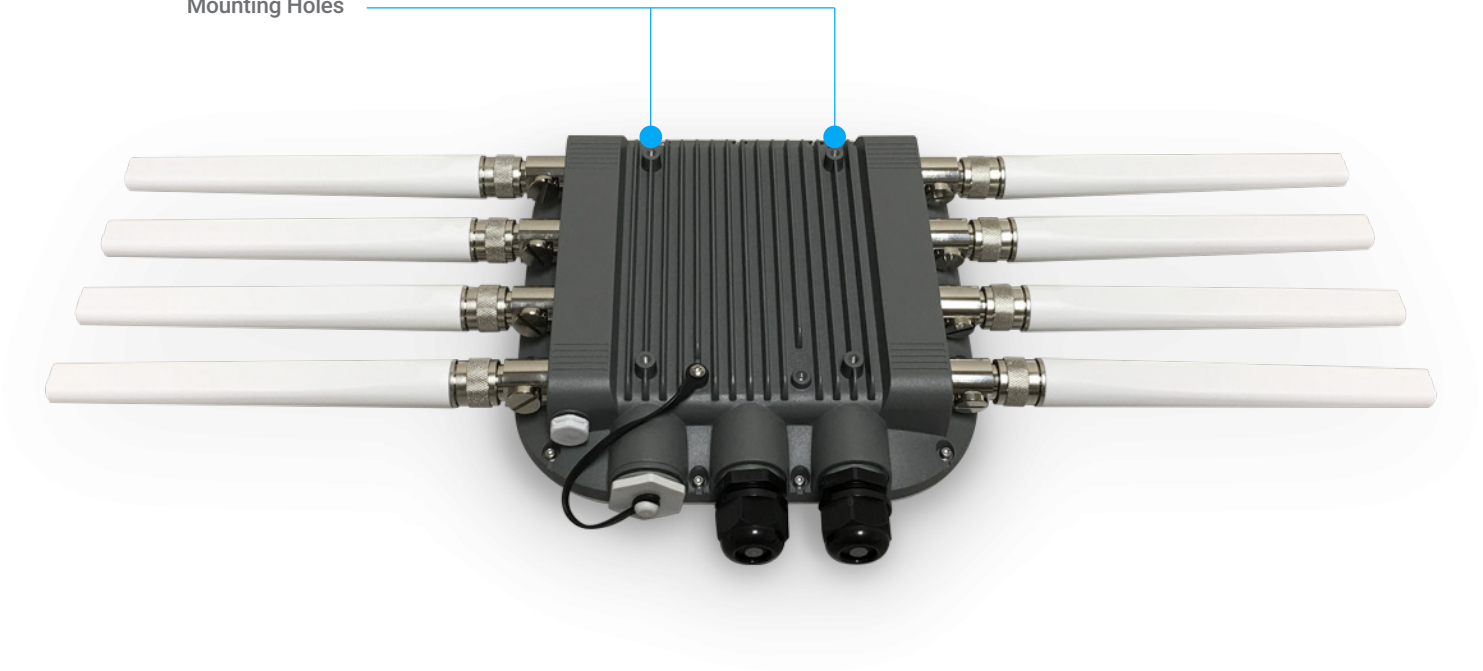

Maximum data rates are based on IEEE 802.11 standards. Actual throughput and range may vary depending on distance between devices or traffic and bandwidth load in the network.

EnGenius Technologies | 1580 Scenic Ave. Costa Mesa, CA 92626

Email: partners@engeniustech.com | Phone: 888-735-7888 | Website: engeniustech.com

Features and specifications subject to change without notice. Trademarks and registered trademarks are the property of their respective owners. For United States of America: Copyright © 2016 EnGenius Technologies, Inc. All rights reserved.